

Owner's Manual

Outboard Motor Series

- 2F
- 2.5F
- 3F
- 3.5F
- 4F



OWNER REGISTRATION AND IDENTIFICATION

Upon purchasing this product, be sure our dealer* fills out the WARRANTY CARD correctly, completely and mails it to the distributor. This card identifies you as the legal owner of the product and serves as your warranty registration. If this procedure is not followed, your outboard motor will not be covered by warranty.

* : In this manual, “dealer” always means an authorized dealer.

PRE-DELIVERY CHECK

Be sure that the product has been checked by the dealer before delivery.

Limited Warranty

This product is fully guaranteed against defective materials and workmanship for the period from the date of purchase, provided that the purchase has been registered in accordance with the above.

The limited warranty will not apply to the normal wear and tear of parts, adjustments, tune-ups, or to any damage caused by, but not limited to:

- 1) Use or operation NOT conforming to the instructions described in this owner’s manual.
- 2) Participation in or preparation for racing or other competitive activities.
- 3) Water entering the engine.
- 4) Damage from accidents, collisions, contact with foreign materials, or submersion.
- 5) Growth of marine organisms on motor surfaces.
- 6) Any other careless use or operation.
- 7) Normal deterioration.

The limited warranty does not cover maintenance items. The following items are a few examples not covered by the limited warranty:

Spark plugs, Anode, Trim-tab, Propeller, Fuel filter, Oil filter, Carbon brush, Starter rope, Shear-pin, Split-pin, Bolt-nut-washer, Wire cable, Rubber goods: water pump impeller, oil seal, “O”-ring, fuel hose, primer bulb, vinyl tube etc.

The limited warranty will become void if the product has been altered, modified, or repaired by anyone other than a company or service firm authorized by

The limited warranty will cover only your product and will not cover the boat the product is mounted on, the trailer, equipment, or accessories associated with the product.

Serial Number

In the space below, please record the engine's serial number (indicated both on the lower motor cover and on the cylinder block). This number will come in handy in the event of theft or to help in quickly identifying the product type.

Serial Number : _____

To You, Our Customer:

Thank you for selecting our product. You are now the proud owner of an excellent outboard engine that will service you for many years to come.

We would like to point out that carefree usage can only be assured on condition that this manual is read through in its entirety and the maintenance routines described later in this manual are followed carefully. Should difficulty arise with the engine, please follow the troubleshooting procedures listed at the end of this manual. If the problem persists, contact an authorized service shop or your dealer.

We hope you will get much enjoyment from this product and wish you good luck in your boating adventures.

CORPORATION

NOTICE: DANGER/WARNING/CAUTION/Note

Before operating your outboard motor, be sure to thoroughly read and understand this Owner's Manual and follow all of the instructions shown. Of particular importance is information preceded by the words "DANGER," "WARNING," "CAUTION," and "Note." Always pay special attention to such information to ensure safe and trouble-free operation at all times.

DANGER

Failure to observe will result in severe personal injury or death.

WARNING

Failure to observe could result in severe personal injury or death.

CAUTION

Failure to observe could result in personal injury, or product or property damage.

Note:

This instruction provides special information to facilitate the use or maintenance of the outboard or to clarify important points.

EMERGENCY STOP SWITCH

The Emergency stop switch will stall the engine when the stop switch tether is pulled out. This line can be attached to the body of the operator, effectively preventing injuries from the propeller in case he/she falls overboard.

We highly recommend use of the Emergency stop switch line. However, we would also like to point out the drawbacks of the switch. Accidental activation of the switch (such as the line being pulled out in heavy seas) could cause passengers to lose their balance and even fall overboard, or it could result in loss of power in heavy seas, strong currents, or high winds. Loss of control while mooring is another potential hazard.

To prevent such hazardous situations, the 500 mm (20 inch.) line is coiled and can extended to a full 1,300 mm (51 inch.).

WARNINGS

As the operator/driver of the boat, you are responsible for the safety of those aboard and those in other crafts around yours, and for following local boating regulations. Therefore you should possess thorough knowledge of correct operation of the boat, engine, and accessories. To learn about the correct operation and maintenance of the engine, please read through this manual carefully.

It is very difficult for a person standing or floating in the water to take evasive action should he or she see a power boat heading in his/her direction, even at a slow speed. Therefore, when your boat is in the immediate vicinity of people in the water, the engine should be shifted to neutral and shut off.

CONTENTS

SERIOUS INJURY IS LIKELY IF A PERSON IN THE WATER MAKES CONTACT WITH A MOVING BOAT, GEAR HOUSING, PROPELLER, OR ANY SOLID DEVICE RIGIDLY ATTACHED TO A BOAT OR GEAR HOUSING.

It is the operator's responsibility to perform all safety checks and to ensure that all lubrication and maintenance instructions are complied with for safe operation. It is also the operator's responsibility to return the unit to the local dealer for periodic inspection.

Correct periodic maintenance and proper care of this outboard engine will lessen the chance of problems and keep overall operating expenses at a minimum.

SERVICING, REPLACEMENT PARTS & LUBRICANTS

Only let an **authorized** service shop perform service or maintenance on this product. Be sure to use genuine parts, genuine lubricants, or recommended lubricants.

MAINTENANCE

As the owner of this outboard engine, you must be acquainted with correct maintenance procedures. Please comply with all instructions concerning lubrication and maintenance, and you should return the engine to the dealer, or service shop, for periodic inspection at the prescribed intervals.

Troublefree operation cannot be expected unless the engine receives adequate periodic maintenance. If proper maintenance is performed, it is not likely that a costly repair will ever be required.

USE OF SERVICE SHOP

We recommend that you use only authorized dealers to carry out all of your maintenance and repair needs.

	Page
1. SPECIFICATIONS	1
2. NAMES OF PARTS	3
3. INSTALLING THE OUTBOARD	4
(1) Position	4
(2) Transom Height	4
(3) Transom Matching	4
(4) Securing the Outboard	5
(5) Adjustment of Outboard Angle	5
4. GASOLINE AND ENGINE OIL	7
5. OPERATION	9
(1) Break-In	9
(2) Starting	10
(3) Starting if Recoil Starter is Out of Order	14
(4) Warm-Up	16
(5) Shifting to Forward	16
(6) Reversing	17
(7) Speed Control	17
(8) Running in Shallow Water	18
(9) Stopping	18
(10) Mooring the Boat	20
(11) Removing and Carrying the Outboard	21
(12) Precautions during Operation	22

6. ADJUSTING THE STEERING RESISTANCE	23
7. INSPECTION AND MAINTENANCE	24
(1) Daily Inspection	25
(2) Periodic Inspection	29
(3) Preparing the Outboard for Long-Term Storage	32
(4) Inspection After Long-Term Storage	33
(5) If the Engine is Submerged in Water	33
8. TROUBLESHOOTING	34
9. TOOL KIT AND SPARE PARTS	36
10. ACCESSORIES	37
11. WIRING DIAGRAM	38

1. SPECIFICATIONS

Model	HD2F	HD2.5F	HD3F	HD3.5F	HD4F
Max.output	1.47KW	1.8KW	2.2	2.6 KW	2.9 KW
Recommended Max RPM	4000-5000	4000-5000	4000-5500	4200-5300	4500-5500
Stroke	2	2	2	2	2
Cylinder	1	1	1	1	1
Displacement(cc)	64	64	64	74.6	79.5
Bore×Stroke	45×40	45×40	45×40	47×43	48X44
Size(mm)	610×240×968	610×240×968	610×240×968	680×288×961	661×296×968 (S) 661×296×1095(L)
Weight	9.8kg	9.8kg	9.8kg	13kg	S:13kg L:14kg
Gear Ratio	27:13(2.08)	27:13(2.08)	27:13(2.08)	24:13(1.85)	27:13(2.08)
Gear Shift Position	F	F	F	F	F-N
Ignition System	CDI	CDI	CDI	CDI	CDI
Cooling System	Water-cooling	Water-cooling	Water-cooling	Water-cooling	Water-cooling
Starting System	Manual	Manual	Manual	Manual	Manual
Control System	Tiller Control	Tiller Control	Tiller Control	Tiller Control	Tiller Control
Standard Capacity of Fuel Tank (L)	1.2	1.2	1.2	1.4	1.4

2. NAMES OF PARTS

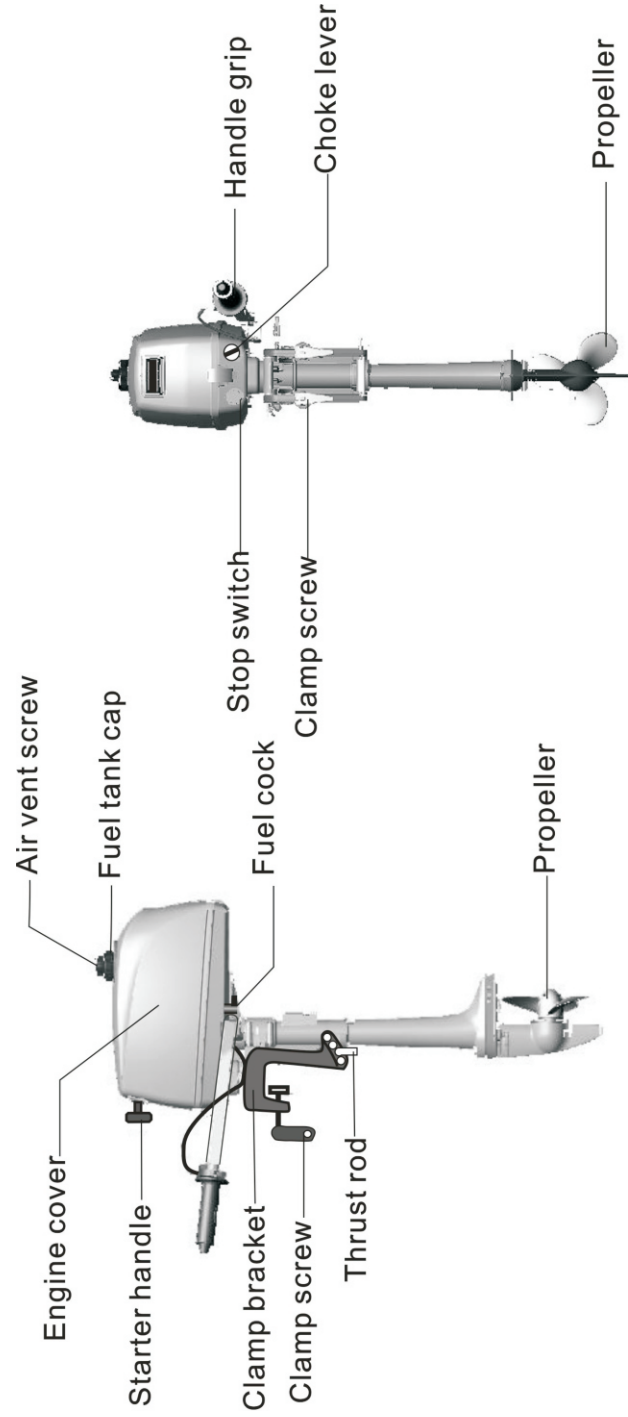

3. INSTALLING THE OUTBOARD

⚠ WARNING

Be sure that the maximum engine horsepower rating does not exceed that recommended for your boat. It is very DANGEROUS to operate a boat with an overpowered engine.

Do not operate the engine until it has been securely mounted on the boat in accordance with the instruction below.

(1) Position

Position the outboard at the exact center of the transom board.

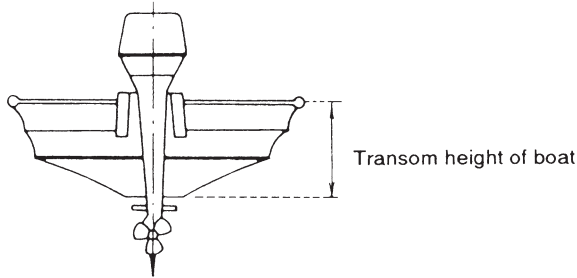

(2) Transom Height

Install the outboard so that the anti-ventilation plate is at a level of 30 — 50 mm (1.18 — 1.97in.) below the bottom line of the boat.

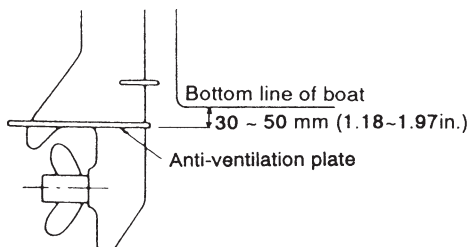

(3) Transom Matching

Be sure that the anti-ventilation plate of the outboard is below the water surface when running with wide open throttle.

In case the above condition cannot be met due to a bottom shape of your boat, please consult your dealer.

(4) Securing the Outboard

Tighten the clamp screws by hand to secure the outboard to the boat.

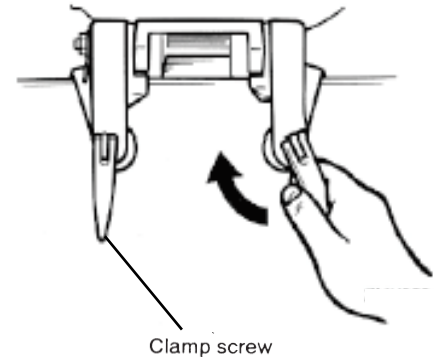

Clamp screw

⚠ CAUTION

During boating, retighten the screws from time to time to ensure safety.

In addition, attach a safety rope or chain to the outboard to prevent possible loss overboard.

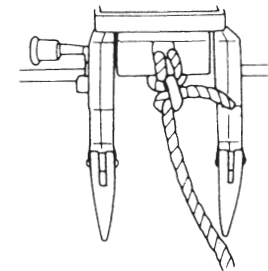

(5) Adjustment of Outboard Angle

The angle of the outboard can be adjusted by changing the position of the thrust rod in the holes provided in the stern brackets, according to the angle of the transom board of the boat, the weight of the load, etc. The angle should be adjusted so that the anti-ventilation plate is parallel to the water surface when the boat is running.

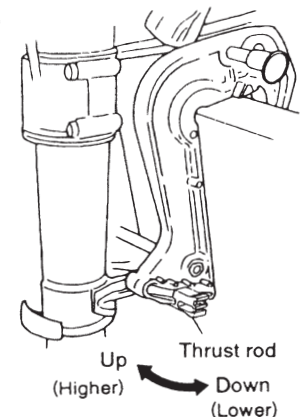

* Correct angle of trim

The optimum angle of trim is obtained when the boat is parallel to the water surface while running.

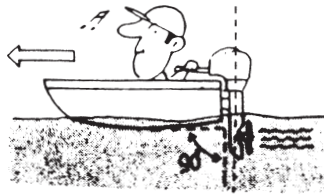

* Incorrect angle of trim (bow rises too high)

If the angle of trim is excessive, the bow will rise out of the water and the speed will decrease. In this case, decrease the angle by setting the thrust rod in a lower hole.



* Incorrect angle of trim (bow dips into the water)

If the trim angle is too small, the bow will dip into water, the speed will decrease, and water may enter the boat.

In this case, increase the angle by setting the thrust rod in a higher hole.



4. GASOLINE AND ENGINE OIL

Gasoline and oil

⚠ DANGER

Gasoline vapors are present, an errant spark could cause an explosion or fire.

- Do not smoke near gasoline.
- Do not overfill gasoline.
If any gasoline is spilt, wipe it up immediately.
- Stop the engine before fill gasoline into the fuel tank.

• Required types

Gasoline

Unleaded gasoline is recommended for outboard motors.

The minimum octane rating should be 87 based on the pump-posted octane rating method (91 based on the research octane rating method).

Note:

- (1) Gasoline containing alcohol {methanol (methyl), or ethanol (ethyl)}, acetone or benzene, may cause:
 - Wear and damage to bearings, cylinder, piston, piston rings.
 - Corrosion of metal parts.
 - Deterioration of rubber parts and plastic parts.
 - Starting, idling, and other engine performance problems.
- (2) Do not use gasoline that contains more than 10% ethanol or more than 5% methanol.
- (3) Damages resulting from the use of gasolines that contain alcohol, acetone or benzene are not covered under the limited warranty.

Engine oil

Use genuine engine oil or the other recommended one, that is, TCW3. We can not recommend any other two-stroke engine oil.

- Mixing ratio (50 : 1)

unleaded gasoline 50: GENUINE ENGINE OIL

or

recommended engine oil (TCW3) 1

5. OPERATION

Note:

Do not mix different brands of oil. The mixing of different brands, or different kinds even if the same brand, may cause gelling, resulting in blockage of filter screens. This may lead to serious engine damage due to the lack of lubrication.

Note:

- (1) Do not use unsuitable or poor-grade gasoline or oil. These may cause serious damage to the outboard and shorten its life span, as well as causing starting problems and other troubles.
- (2) Always use fresh gasoline. Fuel kept in the fuel tank for a long period will produce varnish and gum, which can damage the outboard and create problems in running.
- (3) Use only fuel in which the gasoline and oil have been well-mixed.
- (4) When Filling the fuel tank, be careful that no dust, water or other foreign matter enters the tank.
- (5) Do not fill the fuel tank up to the top of the mouth ring.
- (6) After filling the tank, close the tank cap securely.
- (7) When carrying the fuel tank, close the air vent screw and fuel cock securely, and drain the fuel in the carburetor oil chamber completely by removing the drain plug with a screwdriver.

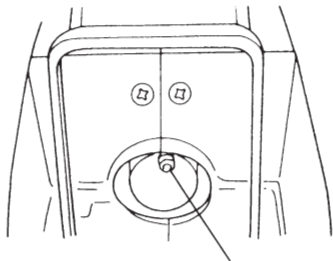

Fuel drain plug of carburetor

(1) Break-IN

The purpose of break-in the engine is to ensure the initial smooth operation of the moving and sliding parts (cylinder, piston, gears, bearings, etc.) so as to protect them from irregular abrasion.

Note:

Break-in period: 5 hours

Fuel (Mixing ratio): Gasoline 25 : Genuine or recommended 2-stroke engine oil 1

Operate the outboard during the break-in period according to the table below:

Time	0 min. —	10 min. —	3 hrs. —	5 hrs. —
Throttle position & Engine speed	① Cruising at minimum speed	② Approx. 500 — 3,500 rpm	③ Approx. 4,000 rpm	④ Available to operate at wide open throttle.

▲ CAUTION

- (1) During the break-in period, never run the engine continuously at high speed.
- (2) After running-in is completed, select the correct propeller so that the engine speed is the recommended range at the wide-open throttle.

⚠ CAUTION

- (1) If the operator fails to follow the break-in procedures, the engine life may be shortened and engine troubles may occur.
- (2) After completing 5 hours of break-in, replace the gear oil with new oil.
Refer to "Changing the gear oil" in subsection (2), Periodic Inspection.

(2) Starting

⚠ CAUTION

- * Do not operate the engine unless the anti-ventilation plate on the gear case is underwater. If the cooling water is not circulating, serious problems will arise and damage may be caused to the water pump, engine, etc.

- ① Fill the fuel tank with the correct fuel mixture. The tank has a capacity of approx. 1.4 liters, permitting the engine to be operated for 30 to 40 minutes. Be careful not to spill any fuel on board. If any fuel or gasoline is spilled, wipe it up thoroughly for safety.
- ② Loosen the air vent screw on the fuel tank cap (2 – 3 turns).

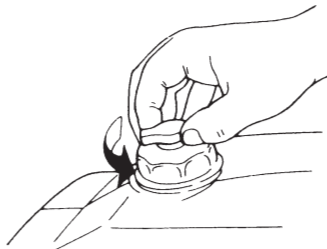

- ④ Turn the fuel cock lever to the "OPEN" position.

Note:

If fuel is not supplied immediately to the carburetor (new engine or after cleaning), wait for about 15 seconds for the proper quantity of fuel to flow into the carburetor after opening the fuel cock.

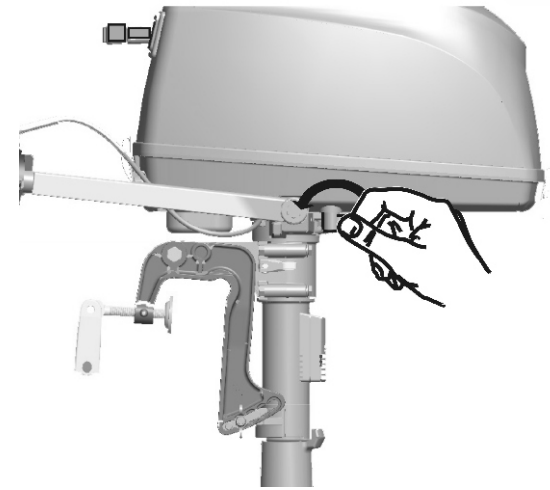

- ⑤ Set the choke lever to the "CLOSE" position.

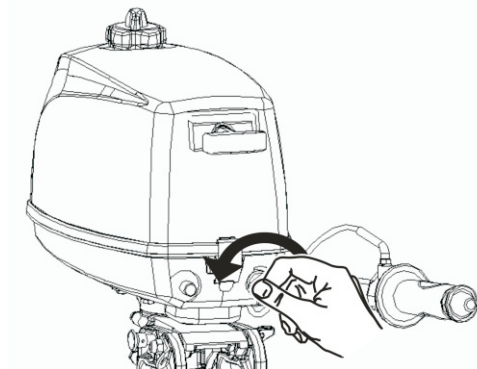

Note:

- (1) If the engine is still warm from previous running, set the choke lever to the "OPEN" position to restart.
- (2) When restarting the engine just after the engine has stopped, never set the choke lever to the "CLOSE" position. If the choke lever is set to the "CLOSE" position, excess fuel will be supplied to the carburetor leading to difficulty in starting the engine.

- ⑦ Ease out the recoil starter grip slowly until you feel the ratchet engage, then give it a sharp tug.

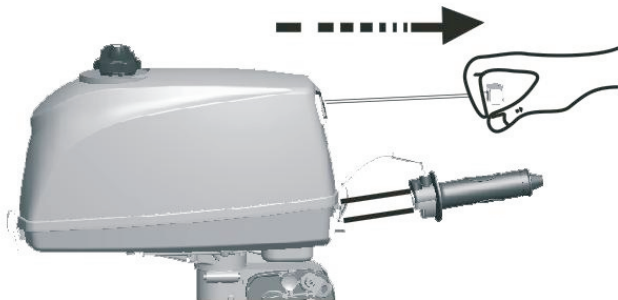

Note:

- * Return the recoil starter grip slowly when the engine has started. Releasing the starter grip at the extended position may cause a trouble in the starting system.

Note:

- * In cold weather, pull the starter handle 2 or 3 times while moving up the choke lever to choke the engine.

- ⑧ When the engine has started, immediately return the choke lever to the "OPEN" position then move the throttle lever downward to slow speed.

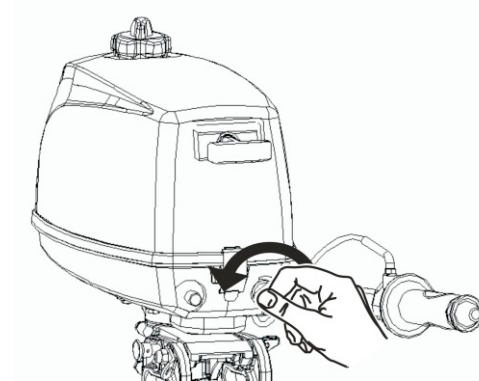

⚠ CAUTION

- * When the shift lever is at the "NEUTRAL" position, never move the throttle lever to medium or high speeds. This may cause serious damage to the engine by rotating it at excessively high speed. (3.5B2)

Note:

* If the engine stops soon after having been started with the choke lever at the "CLOSE" position, set the choke lever to the "OPEN" position and perform the starting procedure again.

(3) Starting if Recoil Starter is Out of Order

Remove the engine cover by releasing the screws, then remove the recoil starter from the top of the fuel tank. Wind the spare starter rope clockwise around the starter pulley about 3 times, and pull the rope to start the engine in same manner as when starting with the recoil starter.

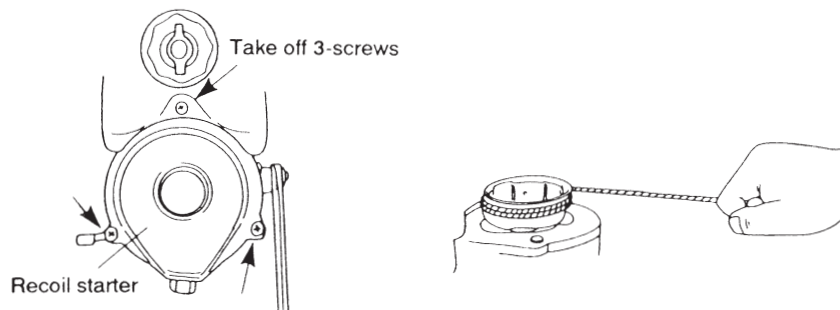

⚠ WARNING

- (1) When the engine cover and recoil starter have been removed for emergency starting, take extreme care that the operator's clothes or other items do not get caught in the rope or other engine parts once the engine starts running.
- (2) Never touch the spark plug or high-tension cable when the engine is running, since they are carrying high-voltage electricity.
- (3) Avoid high-speed running for safety. A medium or low speed is recommended, taking care not to splash water on the fuel tank or electrical parts.
- (4) Once the engine has been started, never attach the engine cover, etc. to avoid danger.
- (5) If the recoil starter is out of order, have it repaired immediately by your dealer. Emergency rope starting should be performed only in the case of emergency.

⚠ CAUTION

- (1) Never remove the carburetor cover.
- (2) Do not leave the connectors of the electrical lead wires in a disconnected condition. The engine cannot be stopped if the lead wire of the stop switch is disconnected. Never disconnect the lead wire connector or touch the lead wires while the engine is running.
- (3) When removing the engine cover, place the screws, etc. in a bag to avoid losing them.
- (4) Take care not to drop the plug cap cover. It is recommended to remove it first.
- (5) When starting using an emergency starting rope, make sure that nobody else is in the vicinity of the engine.

(4) Warm-Up

Before operating the boat, allow the engine to run at low speed for approx. 3 minutes to warm it up and circulate the oil through the engine. If the engine is not warmed up beforehand, the engine life will be greatly shortened. During the warm-up operation, confirm that cooling water is discharged from the check port.

▲ CAUTION

* If cooling water is not discharged and engine operation is continued, the engine will overheat and damage may occur.

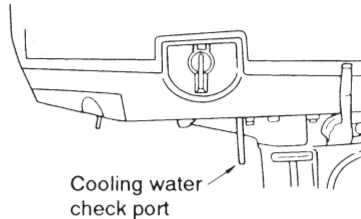

▲ CAUTION

It may be dangerous to attempt shifting at high RPM. Be sure to slow down to trolling or idling rpm before shifting.

(6) Reversing

Return the throttle lever to the "SLOW" position and when the engine speed has reached the lowest rpm, move the shift lever to the "NEUTRAL" (N) position. Stand the steering handle upright and turn the motor 180°. Move the shift lever to "FORWARD" (F) for reverse running. (3.5 only needs to operate shift lever)

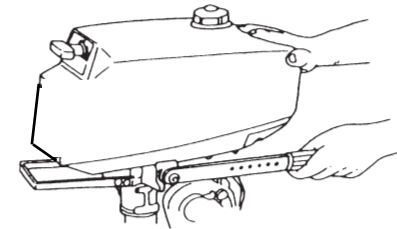

▲ CAUTION

- (1) Before shifting "FORWARD," reduce the engine speed to the idling (low) speed. (3.5 only)
- (2) It is dangerous to run at high speed while reversing. Be sure to operate the engine at low speed.
- (3) If the motor hits an obstruction while reversing, the shock is directly applied to the motor and the boat. This may result in the driver and passengers being thrown out of the boat and may damage both the engine and the boat. Operate the engine carefully to avoid hitting any obstruction when reversing.

(7) Speed Control

The speed is controlled by operating the throttle lever. Moving the throttle lever upward increases the speed, and moving it downward decreases the speed.

▲ CAUTION

- (1) Quick shifting of the throttle lever is dangerous, and may cause a serious accident such as throwing the driver and passengers out of the boat, etc.
- (2) Always decrease the speed of the boat when making a sharp turn.

PROPELLER SELECTION

A propeller must be selected so that the engine rpm measured at wide open throttle while cruising is within the recommended range.

For genuine propellers, refer to ACCESSORIES of this manual.

(8) Running in Shallow Water

Always proceed at a slow speed in shallow water to prevent damage to the motor due to hitting underwater obstacles.

(9) Stopping

- ① Reduce the engine speed to idling rpm, and release the lock of the stop switch or push the stop switch until the engine stops completely.



- ② Close the fuel cock and air vent screw on the fuel tank cap.

▲ WARNING

- (1) This stop switch is provided for the safety of the driver. If the lock is released from the stop switch, the engine will stop. The engine will not start if the lock is in released condition. The emergency stop line should be connected to the driver's wrist, so that the engine will shut down if the emergency stop line is disconnected from the switch in the event of an accident such as the driver being thrown overboard or the boat capsizing.
- (2) Be careful not to entangle the emergency stop line when operating the handle or while running in reverse. If the lock is released when running at high speed, the engine and the boat will stop suddenly. This is dangerous and may cause injury to the driver and passengers.

▲ CAUTION

- (1) The stop switch should be installed only by your dealer.
- (2) Confirm that the stop switch works properly every time before boating.

(10) Mooring the Boat

If the engine will not be operated for a period of time or the boat is moored in shallow water, tilt up the motor to prevent damage to the propeller, gear case, etc. due to hitting rocks in the water or low tide.

⚠ CAUTION

Tilt the motor up so that the propeller is facing upwards and secure the motor with the tilt stopper knob.

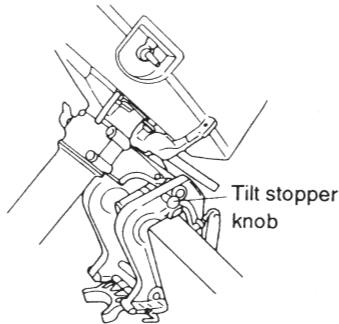

Tilt Up or Down

When tilting up or down, be sure that no finger or hand is placed in between the swivel bracket and stern bracket.

Be sure to tilt down the outboard slowly.

Be sure to close the fuel valve and tank cap breather before tilting up.

* Tilt-up

- ① Close the fuel cock and air vent screw on the fuel tank cap.

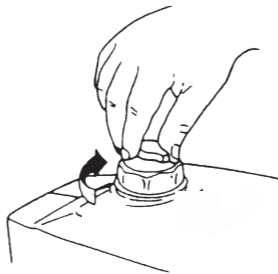

- ② After stopping the engine, tilt the motor up fully toward you by hand and lock the tilt stopper knob in the tilt-up position on the stern bracket.

* Tilt-down

Pull the motor fully toward you and release the tilt stopper knob from the tilt-up position.

(11) Removing and Carrying the Outboard

1. Removing the motor

- ① Stop the engine.
- ② Close the fuel cock and air vent screw.
- ③ Remove the motor from the hull and completely drain the water from the gear case.

2. Carrying the motor

Be sure to keep the engine vertical posture whenever you carry the motor.

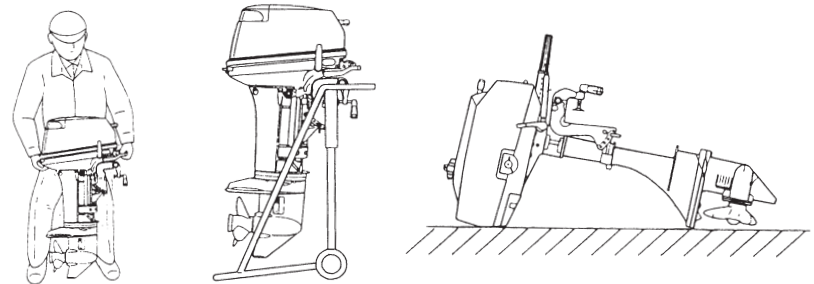

Note:

If you carry or lay the motor horizontal posture, keep the power head higher than the propeller.

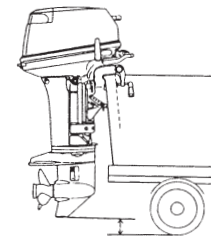

⚠ CAUTION

When trailering the engine installing on a boat, the motor should be in a running position fully tilting down. Trailering at tilted up condition of the motor may cause of damage to the motor, boat, etc. by unexpected tilt lock release getting a shock when trailering.

If trailering the motor at tilt down position is unavailable, fix the motor securely using a device (like a transom saver bar) at the tilting up position.

6. ADJUSTING THE STEERING RESISTANCE

(12) Precautions during Operation

Before boating and while at sea, check the weather and sea conditions, etc. to ensure safety. In the following cases, stop the engine and perform checks as required:

Condition requiring emergency stop	Action to be taken	Items to be checked
* Outboard hits floating wood, a rock, etc.	Stop the engine.	Check damage to the propeller, shear pin, propeller shaft, drive shaft housing, etc.
Engine rpm suddenly increases due to a sharp turn, wave conditions, etc.	Reduce the engine speed and run at medium or low speed.	
Vinyl sheet, debris, etc. becomes entangled in the propeller.	Stop the engine.	Remove entangled vinyl sheet, etc.
* Abnormally little or no cooling water is discharged.	Stop the engine.	Check whether cooling water intake port is blocked and clear as required.
Abnormal vibration or noise occurs.	Stop the engine.	Check clamp screws, bolts and nuts for looseness and propeller for deformation.
* Sudden decrease in engine rpm occurs.	Stop the engine.	Check engine overheating, cooling water discharge, and propeller for irregularity.

Star mark (*) : Return to the nearest marina or port at the lowest possible speed to perform the necessary inspections, and have your dealer carry out repairs if required.

Adjust the steering resistance with the slide adjusting screw. Turning the screw clockwise increases the resistance, while turning it counterclockwise decreases the resistance. This will facilitate smooth steering.

Note:

The steering adjust screw is used to adjust the sliding load of the steering, but not to fix the steering. If excess tightening given to the screw may lead a cause of damage to the swivel bracket.

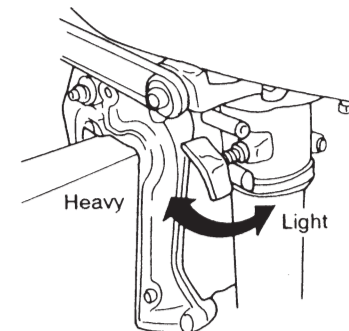

7. INSPECTION AND MAINTENANCE

Care of your outboard motor

To keep your motor in the best operating condition, it is very important that you perform daily, and periodic, maintenance as suggested in the maintenance schedules that follow.

CAUTION

- Your personal safety and that of your passengers depends on how well you maintain your outboard motor. Carefully observe all of the inspection and maintenance procedures described in this section.
- The maintenance intervals shown in the checklist apply to an outboard motor in normal use. If you use your outboard motor under severe conditions such as frequent full-throttle operation or frequent operation in brackish water, maintenance should be performed at shorter intervals. If in doubt, consult your dealer for advice.
- We strongly recommend that you use only genuine replacement parts on your outboard motor. Damage to your outboard arising from the use of other than genuine parts is not covered under the warranty.

EPA Emissions Regulations

EPA (United States Environmental Protection Agency) has emission regulations and is controlling air pollution from new outboard motors. All new motors manufactured by us are certified to EPA as conforming to the requirements of the regulations. This certification is depend upon factory standards. Therefore, factory specifications must be followed when servicing emission related controls, or making adjustments.

Maintenance, replacement, or repair of the emission control devices and systems may be performed by any marine SI (Spark Ignition) engine repair establishment or individual.

(1) Daily Inspection

Perform the following checks before and after use to ensure safe boating.

Item	Check	Action if required
Fuel System	* Check the amount of fuel in the tank. * Check for debris or water in the fuel filter.	Replenish.
Cooling System	* After starting the engine, confirm that cooling water is discharged at the cooling water check port.	If no water is discharged, stop the engine and have your dealer repair it.
Electrical Equipment	* Check the spark plug for dirt and wear. * Check that the emergency stop switch functions normally and make sure the lock plate is present. * Check cords for loose connections and damage.	Clean or replace. Remedy or replace.
Recoil Starter	* Check ropes for wear and damage. * Check the latchet for engagement.	Replace. Correct or replace.
Propeller	* Check the propeller for bent or damaged blades. * Check the split pin is present.	Replace.
Mounting of Outboard	* Check the thrust rod for proper position. * Check the clamp screws for tightness.	Adjust. Tighten.
Anode	Check the anode for wear and/or deformation.	Replace.
Tools and Spares	* To be ready tools and spare parts for replacing spark plugs, propeller, etc. * Check if the spare rope is provided.	

① Washing with fresh water

When the engine has been used in salt water or polluted water, wash the exterior and flush the cooling water passage with fresh water. The cooling water passage is flushed by placing the propeller section of the outboard in a bucket filled with fresh water, and operating the engine for about 3 minutes to circulate the water in the passage.

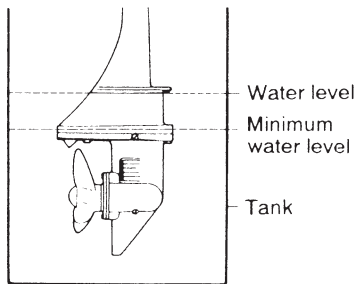

▲ WARNING

Never start or operate the engine indoors or in any space which is not well ventilated. Exhaust gas contains carbon monoxide, a colorless and odorless gas which can be fatal if inhaled for any length of time.

▲ CAUTION

- (1) Set the shift lever to the "NEUTRAL" position before washing. (3.5 only)
- (2) When removing the propeller, remove the plug cap from the spark plug beforehand for safety.
- (3) Wash the exterior of the outboard before long-term storage.
- (4) Run the engine at low speed when flushing the cooling system.

② Precautions in cold weather

When the engine has been used in cold weather below 0°C (32°F), completely drain the cooling water in the engine by standing the engine vertically to prevent trouble due to freezing, then store it. When mooring the boat with the outboard mounted, leave the propeller section submerged in the water.

③ Replacing the propeller and shear pin

- (a) Pull out the split pin from the propeller boss and remove the propeller from the shaft.
- (b) Remove the shear pin from the shaft.
- (c) Install a new shear pin.

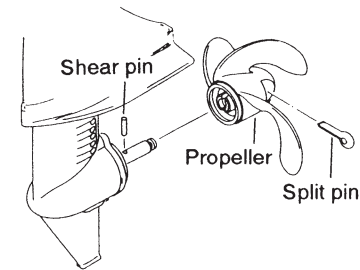

▲ CAUTION

When removing the propeller, disconnect the plug cap from the spark plug for safety.

Note:

- (1) When removing the plug cap, take care not to drop it into the water.
- (2) In order to protect propeller and gears from damage, shear pin is designed so as to be broken when propeller gets strong impact or when the shear pin is used for a longer period of time.
- (3) Always carry a spare split pin and shear pin. When the spare has been used, supply a new one. A damaged or worn split pin or shear pin should be replaced with a new one.

④ Replacing the spark plug

Replace the spark plug if there is dirt or carbon deposits around the electrode, if the insulator is damaged.

- (a) Remove the plug cap cover and remove the spark plug.
- (b) To remove the spark plug, turn it counterclockwise with the socket wrench provided (21mm). Tap lightly on the spark plug if it is hard to turn.

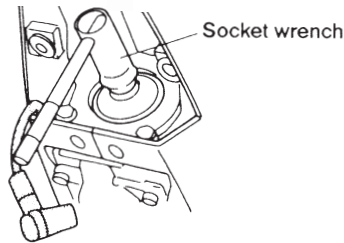

- (c) When fitting the spark plug, screw it in by hand first then tighten it using the socket wrench.

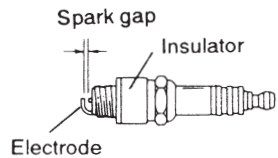

Note:
Tighten the spark plug by 1/2 – 3/4 turn to secure it after it touches the washer on the cylinder head.

Spark plug	NGK BP6HS-10, NGK BPR6HS-10 or CHAMPION L-87YC, RL-87YC (Gap 1.0)
Spark gap	0.9 – 1.0 mm

- (d) Fit the plug cap cover securely so that it will not come loose when the engine is running.

⚠ WARNING

Never remove the plug cap cover when the engine is running. It is dangerous to touch the high-tension cable inside the plug cap cover.

(2) Periodic Inspection

Item	10 hours or 1 month	50 hours or 3 months	Every 100 hours or 6 months	Action	Remarks
Carburetor	★		★	Strip, clean and adjust.	
Fuel Filter	○	○	○	Check and clean.	
Piping	○		○	Check pipes for damage, and for any leaks at connections.	
Fuel Tank	○	○	○	Clean.	
Spark Plug	○	○	○	Check the spark gap.	
Starter Rope	○	○	○	Check for wear or damage.	
Water Pump			★	Wear or damage.	
Propeller	○	○	○	Check propeller for bending, damage or blade wear.	
Shear Pin & Split Pin	○	○	○	Check for bending or damage.	
Gear Oil	○	○	○	Replenish or change if required.	
Bolts and Nuts	○	○	○	Tighten properly.	
Sliding and Moving Parts		○	○	Apply grease.	
Outer Surfaces	○	○	○	Check for corrosion.	
Anode		○	○	Check corrosion and wear.	

Note:

Your outboard motor should receive careful, and complete, inspection at 300 hours. This is the best time for major maintenance procedures to be carried out.

Note:

(○) mark : Items for which inspection and the necessary action should be performed by the owner or operator.

(★) mark : Consult your dealer.

The inspection periods shown in this table are applicable only in the case of normal use. If the outboard is subjected to severe use such as for commercial purposes, the inspections should be carried out more frequently.

① Replacing the anode

The outboard is equipped with a sacrificial anode on the upper portion of the gear case to protect the motor from corrosion.

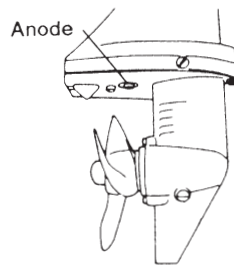

▲ WARNING

When removing the anode, disconnect the plug cap from the spark plug to prevent injury due to accidental starting of the propeller.

Note:

- (1) If the anode has worn out or is not fitted, the aluminum material of the outboard may become corroded resulting in peeling of the paint and damage to the motor.
- (2) Never apply paint or grease to the anode.

② Changing the gear oil

- (a) Set the outboard in an upright position. Place a drain pan under the gear case. Remove the lower drain plug first, and then remove the upper oil plug. Drain the oil completely.
- (b) Insert the oil tube nozzle into the lower oil plug hole, and squeeze the tube until the oil flows out of the upper plug hole.
- (c) Install the upper oil plug. Then remove the oil tube nozzle and install the lower oil plug.

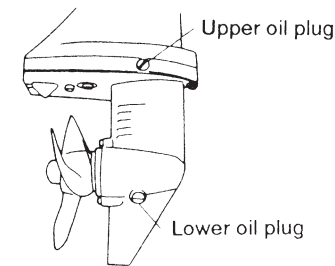

Note:

- (1) Use genuine gear oil or, if not available, use an API (American Petroleum Institute) oil grade of GL5, SAE #80 or #90.
- (2) Required volume: Approx. 180mL (6.08 US fluid oz)
Approx. 90mL (3.04 US fluid oz)

▲ CAUTION

- (1) Treat the drained gear oil in the proper way as an industrial waste.
- (2) If the drain oil is found to be a milky color when changing the gear oil, this indicates water suck into the gear case. In this case, contact your dealer immediately to make an inspection and perform any repairs necessary so as to avoid serious mechanical damage.

(3) Preparing the Outboard for a Long-Term Storage

- ① Wash the engine exterior and flush the cooling water system thoroughly with fresh water. Allow the water to drain completely. Wipe off any water on the surface with an oil rag.
- ② Drain all fuel from the fuel pipes, fuel cock and carburetor, and clean the parts including the mesh in the fuel cock.
- ③ Disassemble the carburetor, remove any internal dust, and clean it using gasoline and air.
- ④ Remove the spark plug and feed engine oil or storage fogging oil through the spark plug hole. Pull the recoil starter handle a few times to circulate the oil to the internal parts.
- ⑤ Apply grease to the propeller shaft.
- ⑥ Change the gear oil in the gear case.
- ⑦ Apply grease to all sliding parts, bolts and nuts.
- ⑧ Wipe off any water and salt on the electrical components using a dry cloth.
- ⑨ Stand the outboard vertically in a dry and ventilated place.

Note:

Treat the fuel and oil drained from the fuel tank, carburetor, gear case, etc. in the proper way.

(4) Inspection After a Long-Term Storage

- ① When using the outboard for the first time after a long period of storage, it is recommended to:
 - warm-up the engine for about 3 minutes.
 - run the engine at slow speed for about 5 minutes, then.
 - run the engine at medium speed for about 10 minutes.
- ② Use fresh fuel mixed at a ratio of 25:1

(5) If the Engine is Submerged in Water

In case the engine becomes completely submerged in water, after picking up, immediately bring the outboard to your dealer.

Followings are the emergency measures to be taken on the submerged outboard.

- ① Take it out of the water immediately and wash it with fresh water to remove all traces of salt and dirt.
- ② Remove the spark plug, and drain the engine completely of water. Turn the flywheel several times by pulling the starter rope handle to drain any remaining water in the engine.
Drain the fuel line and the carburetor.
Inject a plentiful amount of engine oil or storage fogging oil into the engine through the spark plug hole and the air silencer.
- ③ After the above steps, it may be possible to start the engine. However, the electrical components and carburetor will soon deteriorate and become inoperative. Therefore, be sure to have the engine overhauled by your dealer as soon as possible.

8. TROUBLESHOOTING

If you encounter a problem, consult the checklist below to locate the cause and then take the appropriate measures.

Regular checks and servicing by your dealer are recommended, to ensure maximum safety and optimum performance.

Engine fails to start.	Engine starts but stops soon.	Poor idling	Engine speed abnormally high	Engine speed abnormally low	Slow speed	Overheating of engine	Possible cause
●	●						Empty fuel tank
●	●						Incorrect connection of fuel system
●	●	●		●	●	●	Air entering fuel line
●	●	●		●	●	●	Deformed or damaged fuel pipe
●	●	●		●	●	●	Closed fuel tank cock or air vent on fuel tank
●	●	●		●	●	●	Clogged fuel filter, fuel pump or carburetor
●		●		●	●	●	Use of improper engine oil
		●		●	●	●	Use of improper gasoline
		●		●	●		Excessive oil in mixture
						●	Insufficient oil in mixture
●							Excessive supply of fuel/Spark plug wet with fuel
●	●	●		●	●	●	Poor carburetor adjustment
	●	●		●	●	●	Spark plug other than specified
●	●	●		●	●		Dirt or bridge on spark plug
●	●	●		●	●		No or weak spark

Engine fails to start.	Engine starts but stops soon.	Poor idling	Engine speed abnormally high	Engine speed abnormally low	Slow speed	Overheating of engine	Possible cause
				●	●	●	Insufficient cooling water flow/Clogged or defective pump
			●		●	●	Anti-ventilation plate damaged or deformed
			●	●	●	●	Incorrect propeller selection
		●	●	●	●	●	Damaged or bent propeller
			●		●	●	Improper thrust rod position
			●	●	●	●	Unbalanced load position on boat
			●	●	●	●	Transom too high or too low
●							Short-circuit of engine stop switch
●							Stop switch lock released
			●				Sheared shearpin

9. TOOL KIT AND SPARE PARTS

Name		Quantity	Remarks
Tool Kits	Tool Bag	1	
	Pliers	1	
	Socket Wrench	1	21mm
	Handle for Socket Wrench	1	
	Phillips Screwdriver	1	No. 2
※ Spare Parts	Spark Plug	1	NGK BPR6HS-10
	Shear Pin	1	
	Split Pin	1	
	Rope	1	

※ Not included as standard accessories in some markets.

10. ACCESSORIES

Note: A stainless steel shear pin must be used for propeller marked. ※

A propeller must be selected so that the engine rpm measured at wide open throttle while cruising is within the recommended range.

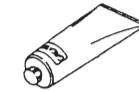

Genuine grease
(250g)

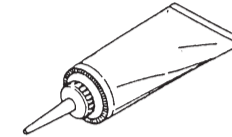

Genuine gear Oil
(500mL)



Propeller



Touch-up paint

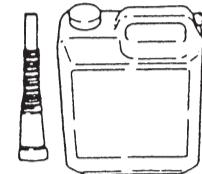

Genuine engine Oil
(0.4L, 1L, 4L, 20L)

11. WIRING DIAGRAM

